



**WINDOWS
PATIO DOORS
BIFOLDING DOORS
ENTRANCE DOORS
ROOFLIGHTS
CONSERVATORIES
SCREENS**

ALLSTYLE
COMPLETE ALUMINIUM GLAZING SYSTEM

ALUMINIUM WINDOWS DOORS & CONSERVATORIES

Aluminium is a high-strength & lightweight material used in every facet of the modern construction industry. From patio doors, to curtain-walling in commercial buildings - Allstyle manufacture products for many applications in an almost limitless range of styles and colours to suit any project.

The polyamide thermal break in our product range achieves excellent thermal insulation, and meets building regulations Part L with considerably reduced u-values.

Contact us today to discuss your next building or home improvement project.





ALLSTYLE IS THE COMPLETE GLAZING SYSTEM FOR RESIDENTIAL & COMMERCIAL BUILDING PROJECTS



SLEEK AND CONTEMPORARY STYLING



LIGHT AND SPACE

The strength to weight ratio of aluminium allows us to make frames with slim profiles that are neat in appearance while also allowing natural light into your property. We can also create larger frames in aluminium to reduce sightlines and help you make the most of the view out of your home.



OUR RANGE OF ALUMINIUM BIFOLDING DOORS ALLOW YOU TO SEAMLESSLY MERGE YOUR HOME OR CONSERVATORY WITH YOUR GARDEN AND THEY ARE COMPLEMENTED PERFECTLY BY THE ALLSTYLE FLUSH LOOK WINDOW SYSTEM.

BIFOLDING DOORS

Allstyle bifold doors, manufactured from slim thermally broken aluminium profiles, provide strength and security. Fold and slide the panels back to the left or right and open up expansive, unobstructed, access to a patio, garden or outside space.

Folding doors for internal use can be specified with a low threshold or a rebated track so that two floor levels can remain constant. Visofold aluminium folding doors have a low threshold which can be recessed into the floor.

- Reduced sightlines
- Square or rounded edge profile options.
- Fabricated using mitred corners
- Marine grade powder coat available
- u Value: 1.5W/m²K achievable with a 1.0W/m²K centre pane glass unit
- Frame Width: 102.5mm
- Frame Depth: 70mm
- Glass: 28mm double/triple glazed
- Max o/a height (per sash): 2500mm
- Max o/a width (per sash): 1200mm
- Max Sash Weight: should not exceed 100kg
- Doc L 2010: Yes

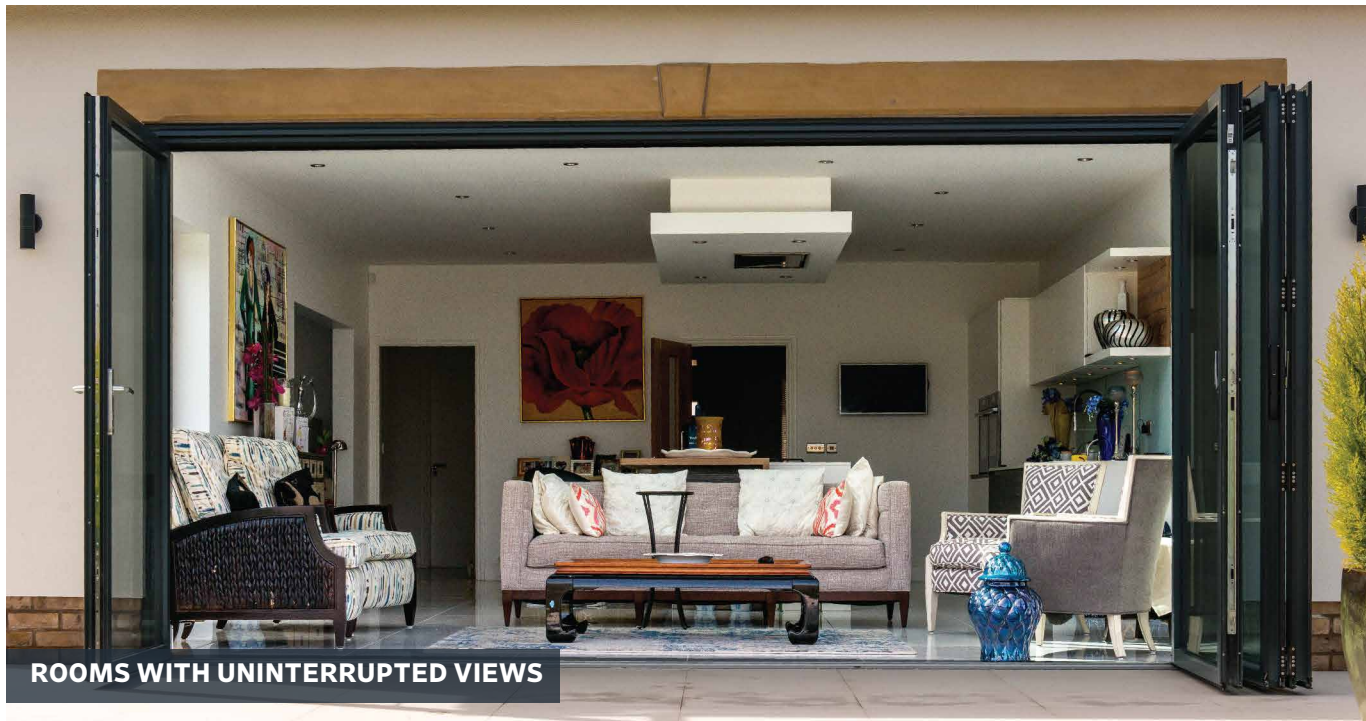
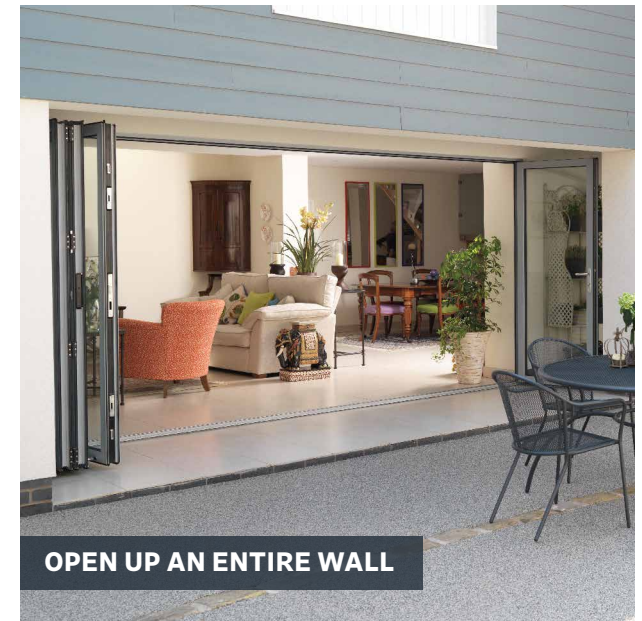

FLEXIBLE DESIGN

Allstyle bi-folding doors take up much less room than a standard door, without the need to centre them on a supporting wall. Common door arrangements can be seen to the right.

These doors can be up to 2.5 metres high and have a maximum panel width of 1200mm. Traffic doors can hinge like a conventional door or as a French door.

These door arrangements are shown opening to the left but are also available opening to the right, and opening inwards or outwards.

2 & 3 Panel



4 PANEL

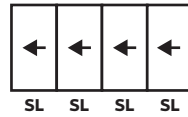

5 PANEL

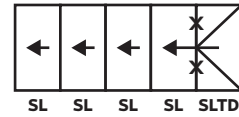

6 PANEL

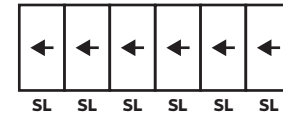

KEY

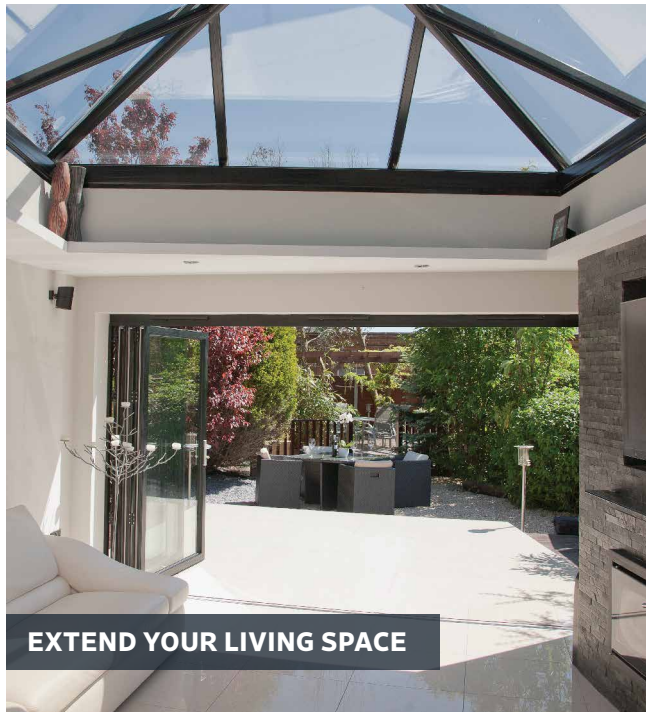
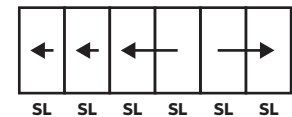
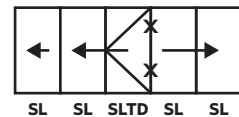
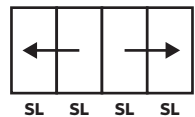
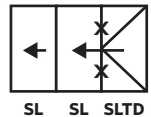
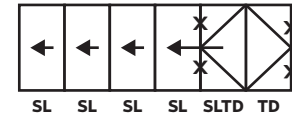
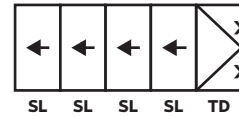
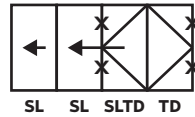
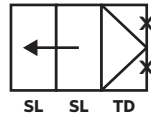

EXTEND YOUR LIVING SPACE



FLEXIBLE DESIGN OPTIONS FOR ANY APPLICATION



CENTRE GLASS TO GLASS SIGHT LINES FROM 143MM

SLIMLINE FRENCH DOOR



FEATURE RICH, MODERN BIFOLDING DOORS



Bifolds are available with threshold and cill options too, allowing you to blend inside and out. Choose from a rebated (weathered) threshold or low thresher and cills. Bifolds run smoothly inside tracks.



Stainless steel or matching coloured hardware like handles and hinges is available. Optional keyed locking on slave handle(s) to further secure, & multi-point locking systems for ultimate security on bifolds.



We are able to powder coat to any RAL colour in both single and dual colour, and can supply a matte finish. A marine grade powder coat is also available if required.



Integrated blinds can be installed within our sealed glass units and are available in a range of colours to complement your windows, doors and decoration.



INTEGRATED BLIND SYSTEMS

RAISING



LOWERING

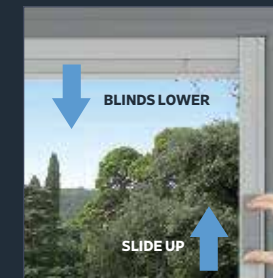

TILTING





TWIN & TRIPLE TRACK DOORS ALLOW MUCH WIDER PANELS THAN A BI-FOLD

SLIDING PATIO DOORS

Allstyle sliding patio doors will truly give you a room with a view. Robust aluminium sections allow the creation of wide passage-ways and huge glazed areas with fewer sightlines. Your views will have less frame and more glass, meaning maximum natural light.

Panels that slide to the left or right sit within an outerframe and there is a wide range of sliding combinations. Allstyle patio doors are perfect for balconies.



REDUCED SIGHTLINES



CREATE LARGE GLAZED OPENINGS WITH ALLSTYLE ALUMINIUM SLIDING DOORS

Key features of our sliding patio doors:

- Domestic and commercial use as fixed lights & horizontal sliding doors.
- Weight limit 300Kg (sash)
- Doc L compliance
- u-Value: 1.6 W/m²K based on using a sealed unit with 1.0 W/m²K centre pane
- Polyamide thermal break to allow dual colour
- Double or triple glazed units
- Huge range of powder coat colours and finishes.

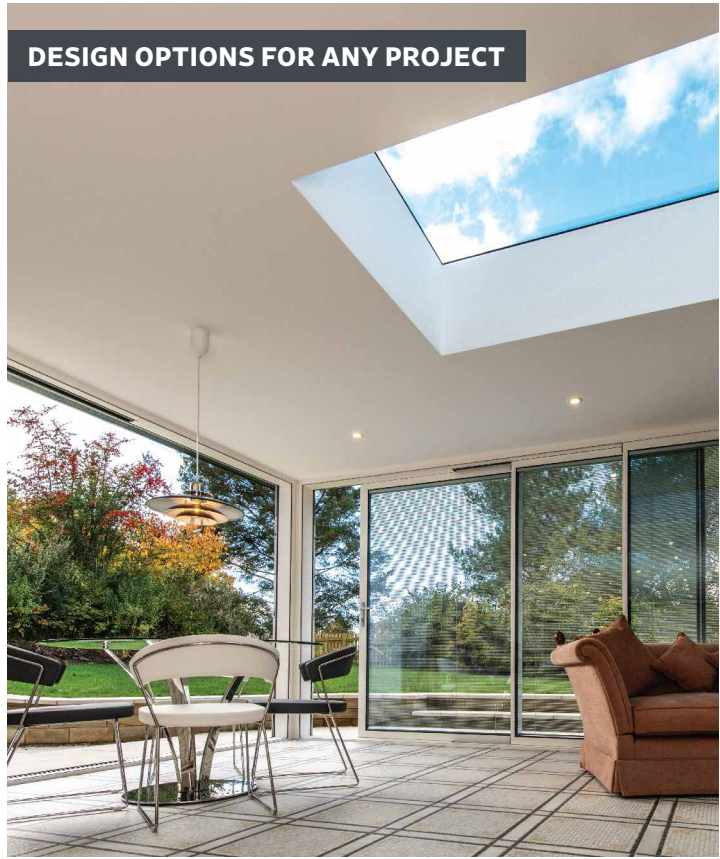

DESIGN OPTIONS FOR ANY PROJECT

ALUMINIUM WINDOW SYSTEMS

Aluminium is the smart choice for any renovation or homebuilding project. It combines strength and durability in a lightweight material, allowing slim frames to create clean designs.

Made to measure, our windows can be manufactured as fixed windows, side hung, top hung, open out, sash windows, tilt and turns, angled windows and bay windows. They are all appropriate for both residential and commercial applications.



Multi-point steel locking mechanisms that exceed the British Standards for security, & key-locking handles on opening lights.



Allstyle windows and doors are thermally efficient, contributing to a reduction in the cost of your heating bills.



Manufacture in any RAL colour and with a matte finish. Dual colour coating available for inside/outside, where required too.



Our aluminium frames are virtually maintenance free and will provide you with years of service.



Concealed trickle ventilation option, maintaining the stylish look of aluminium windows from visible night vent hoods.



THE *FLUSH LOOK* WINDOW SYSTEM

The Allstyle Flush Look is a window system that is seamless in appearance, with sleek and slim sightlines.

Viewed externally, the opening sash sits level with the outer frame in the closed position. This provides a sight line which is much more appealing to the eye than a traditionally made casement window.

Designed for top or side-hung, opening-out windows, this unique window is manufactured exclusively in the UK. We have a wide selection of carefully selected hardware to suit any design and what's more, the Flush Look system complements our bifolding doors perfectly.

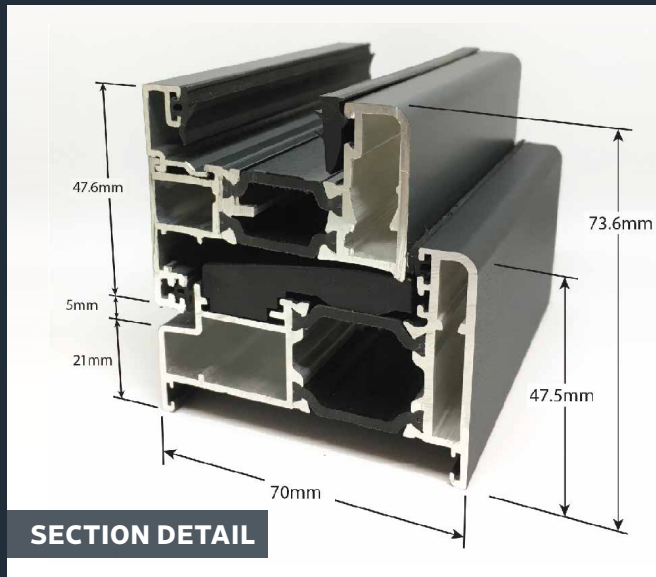
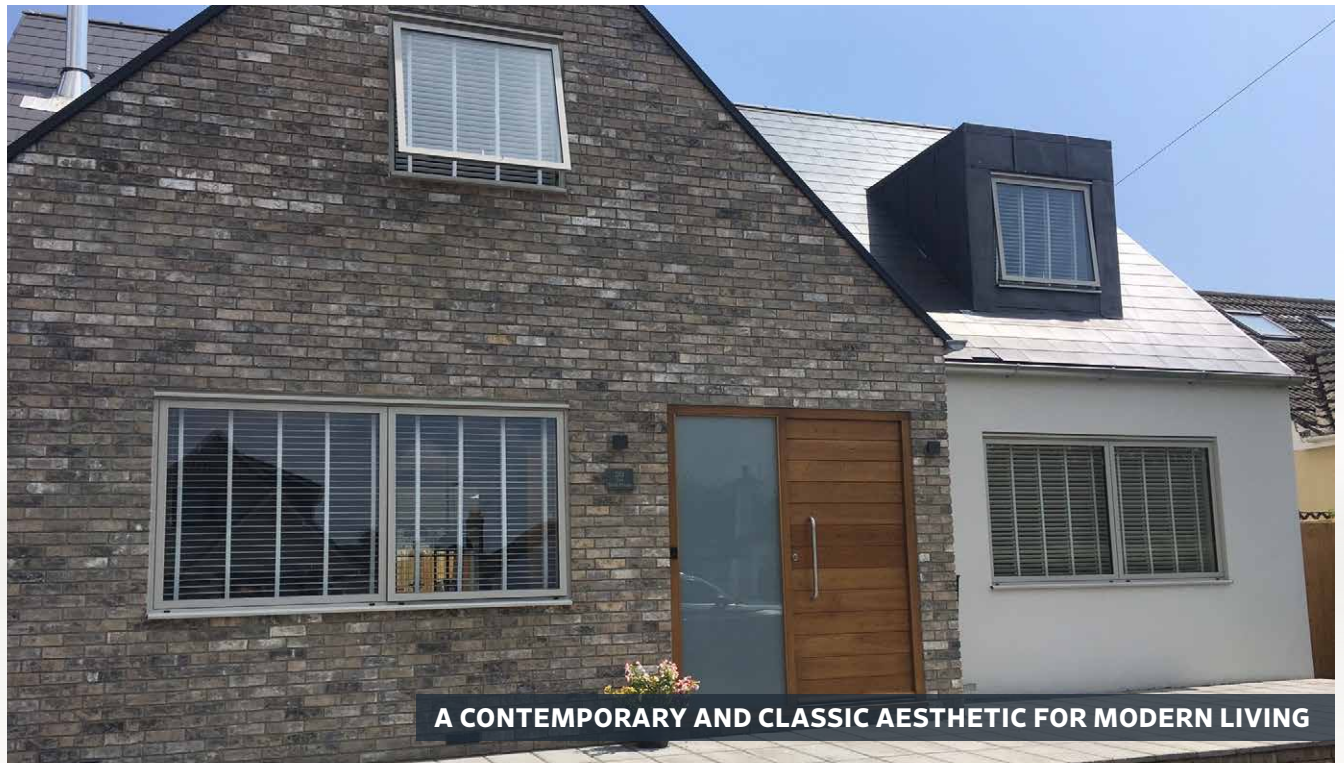

Allstyle *Flush Look* Window Features & Specifications:

- High-Security bi-directional pincer multi-point mechanism with key lockable night vent position
- Fully compliant with Doc L of the Building Regulations (Conservation of Fuel and Power)
- Compliance with Document Q when specified
- Window Energy Rating up to A
- Concealed Night Ventilation available where required
- Concealed mullions and Transoms with slim sash to sash sightlines of just 102mm
- The in-line flush look is a perfect match with our bifolding doors.

Sash Sizes

- **Top Hung** – max. sash size: 1400x1300mm (40kg)
Friction Stays – (up to and including) 24"
- **Side Hung** – max. sash size: 700*x1400mm (28kg)
Friction Stays – (up to and including) 16"
*800mm with Fire Escape Hinges

SASH-TO-SASH SIGHTLINES

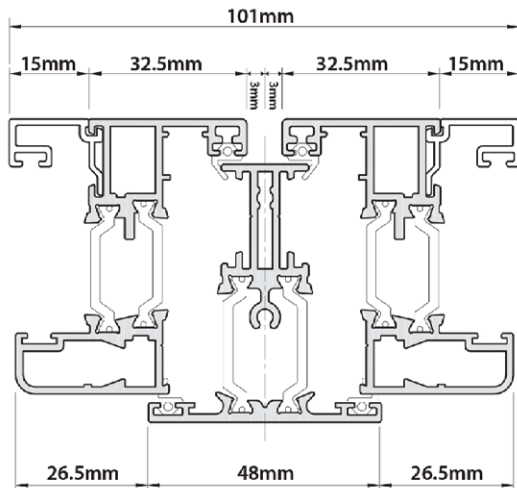

FINISHING TOUCHES AND FURNITURE

Tear Drop & Monkey-Tail Handles

With an elegant design that has been inspired by traditional 19th century ironmongery, Tear Drop or Monkey-Tail Handles are the perfect finishing touch for the Flush Look Aluminium Window.



- Strength tested to equivalent of a modern espagnolette window handle
- Strong espagnolette operator
- Manufactured from die-cast zinc with specially formulated finish
- Harder wearing finish than traditional wrought iron furniture
- Matching dummy & operating stays available
- Create a perfectly matching heritage window
- Key locking & Security enabled



Hardex Chrome

Hardex Satin

Hardex Gold

Antique Black



MINIMAL SIGHTLINES, MAXIMUM LIGHT & VIEW



White

Black

Silver

Gold

Espagnolette Handle

- A die-cast aluminium lever that is the perfect balance of price and performance.
- Solid zinc baseplate for stability and security.
- Includes a heavy-duty sprung latching block with a positive and reassuring *click* on closing.
- Long handle, with 50mm window clearance for greater leverage. Easily operated without catching a hand on the window.
- A classic design with a contemporary twist so you can create an elegant and stylish window.
- Patented cover caps with colour coordinated finish. Perfectly matching components, even down to the smallest details.

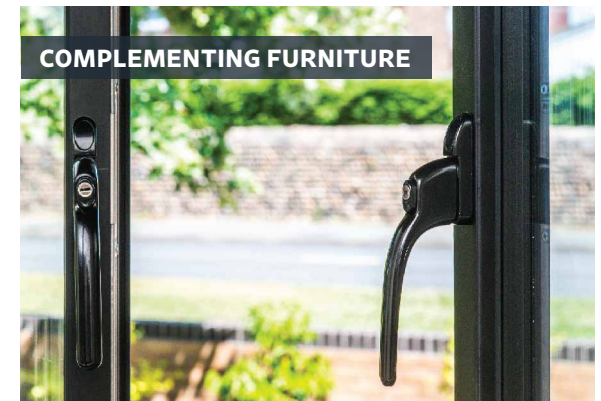

COMPLEMENTING FURNITURE

BESPOKE SOLUTIONS

As one of the UK's largest and most experienced manufacturers, we have a wide knowledge base and a vast combined experience in the design and production of a range of truly bespoke glazing solutions.

Contact us today for assistance with your next home improvement, renovation or building project.



TILT & TURN WINDOWS

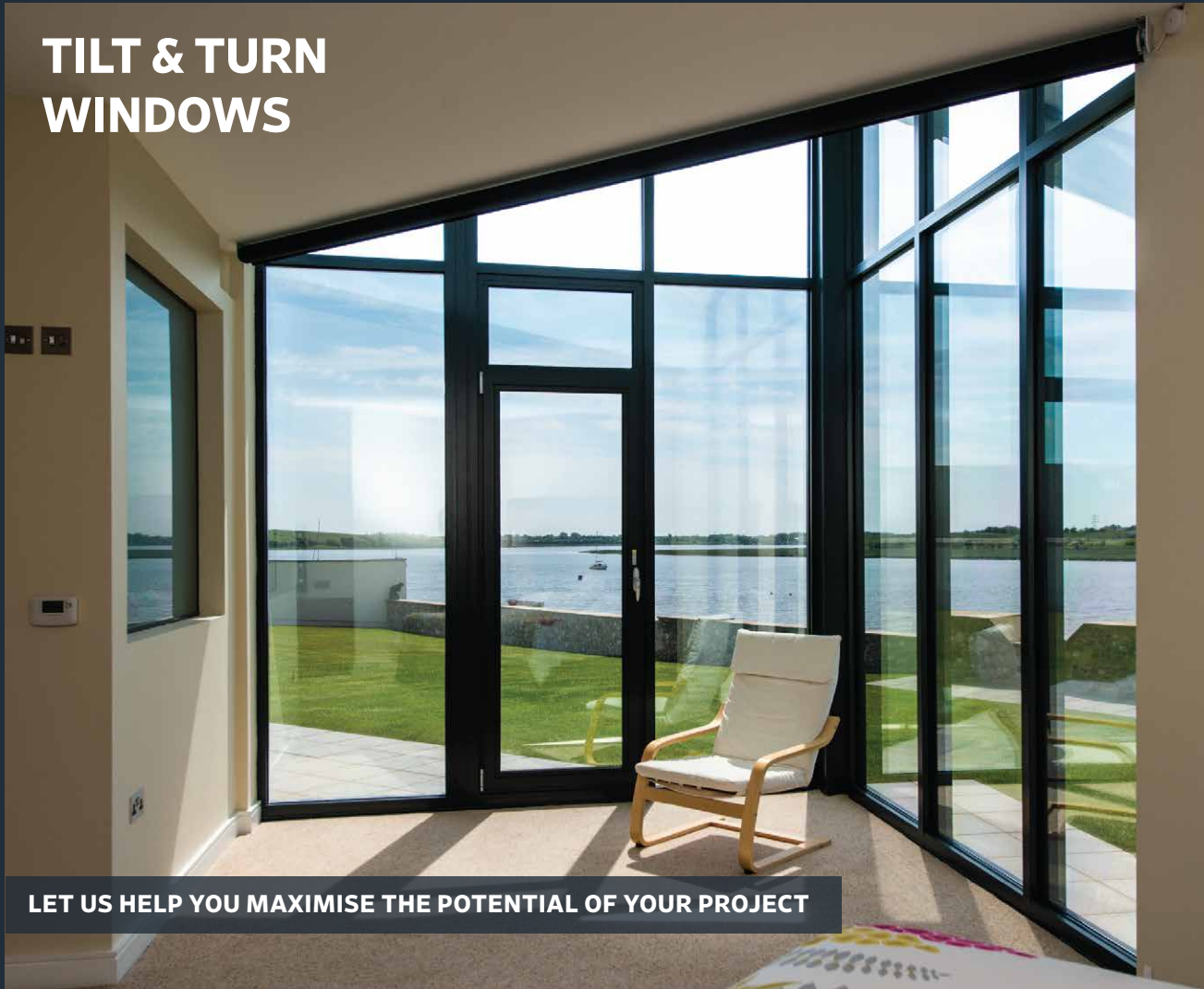

LET US HELP YOU MAXIMISE THE POTENTIAL OF YOUR PROJECT

For those looking for a sleek design that can give both excellent ventilation and a much larger opening potential, the Allstyle Tilt and Turn is the way forward. Opening in, Tilt and Turn windows are perfect for a balconies and low level glazing where an open out window just won't do. Larger apertures are also possible with Tilt and Turn.

Allstyle Tilt and Turn windows are available with all of the same matching finishes and fixtures as our other window and door systems.

In the *Tilt* position, windows can open inwards from the bottom (as below) allowing you to open windows for ventilation while maintaining security.

The *Turn* position allows the window to open fully inwards in the normal way from the side. Flexibility is the key advantage of Tilt & Turn windows.



A SECURE VENTILATION OPTION

STAINLESS STEEL HARDWARE

Our ranges of window and door systems are suitable for all sorts of projects. Whether they are old or new buildings, choosing the right furniture and finishing touches for your project can make all the difference. You could choose a bold and modern statement handle, or something more classic - the best options are made from marine grade stainless steel.

Marine grade stainless steel is most suitable for exposed locations, but is popular across our product ranges. Choosing marine grade stainless steel for your window and door furniture will ensure that your project looks and performs well for years to come.



'T' BAR PULL HANDLES FOR ENTRANCE DOORS

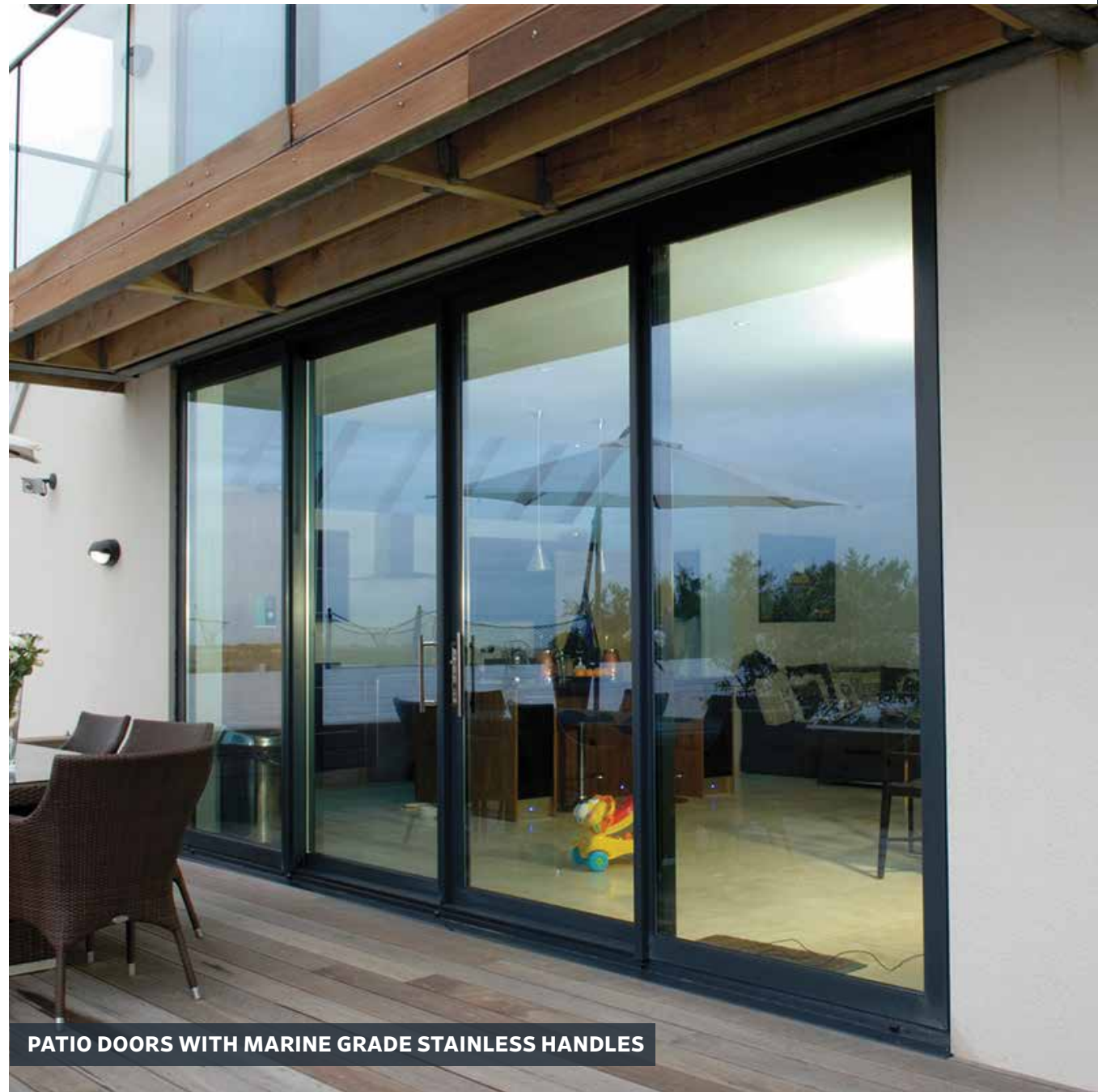

PATIO DOORS WITH MARINE GRADE STAINLESS HANDLES

Patio Door Handles

A contemporary and modern looking straight slide handle, suitable for patio doors - manufactured in the marine grade stainless steel.



For Entrance Doors

An angled modern 'T' Bar Pull Handle, designed for doors that might require the handle to be offset from its fixing point.

Manufactured in marine grade stainless to ensure durability even in the most extreme environments.



Window Hardware

A sleek and lockable Espagnolette handle, sprung to keep the lever in place and with a cranked handle to prevent clashing on the frame.



Bifolds and Residential doors

Make your bifolds and residential doors stand out with the straight lines and contemporary design of this marine grade handle.

It has dual springs to ensure that it always returns to 90°

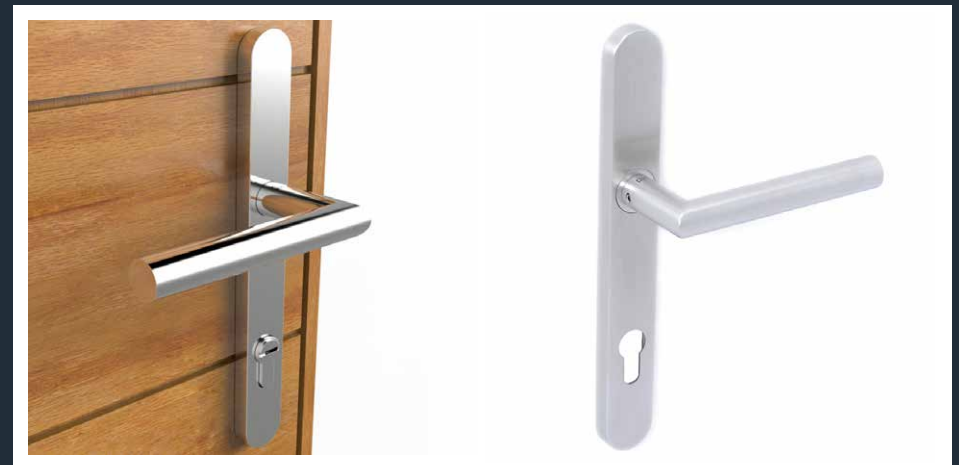

ALLSTYLE DESIGNER DOORS

A carefully assembled range of doors to suit all types and style of home. The modern and stylish Designer Doors offer a wide range of designs, colours and styles for you to choose from.

Precision construction and high-quality locking mechanisms combine to give strength and security. Glazing choice and door furniture have such an impact on the overall appearance - choose from fixed, side, or head-light glazing combinations, as well as single or double doors to create your perfect design.

An extensive selection of colours and a range of stainless steel door handles, knockers and letter-plates provide those perfect finishing touches.

Every door is manufactured by specialists so that whatever the weather, you can be certain that your door is engineered to last.

High Security and Performance as Standard:

- Tested to PAS 24:2016 Enhanced Security Performance
- 3 adjustable hinges & resistant to 80kg of pressure
- 66mm triple glazed and laminated glass units
- All profiles include a polyamide thermal barrier that enhances thermal performance
- Thermally efficient, with a u-value from 0.9W/m²K to 1.1W/m²K, dependant on the glass specified
- Double-rebated EPDM centre gaskets provide maximum weather protection
- 10-point locking for high security
- Hardened stainless steel and picking protection pins provide tamper-protection
- Laser-cut key profiles prevent use of unauthorised keys
- Hidden hinge protectors - security against external impacts

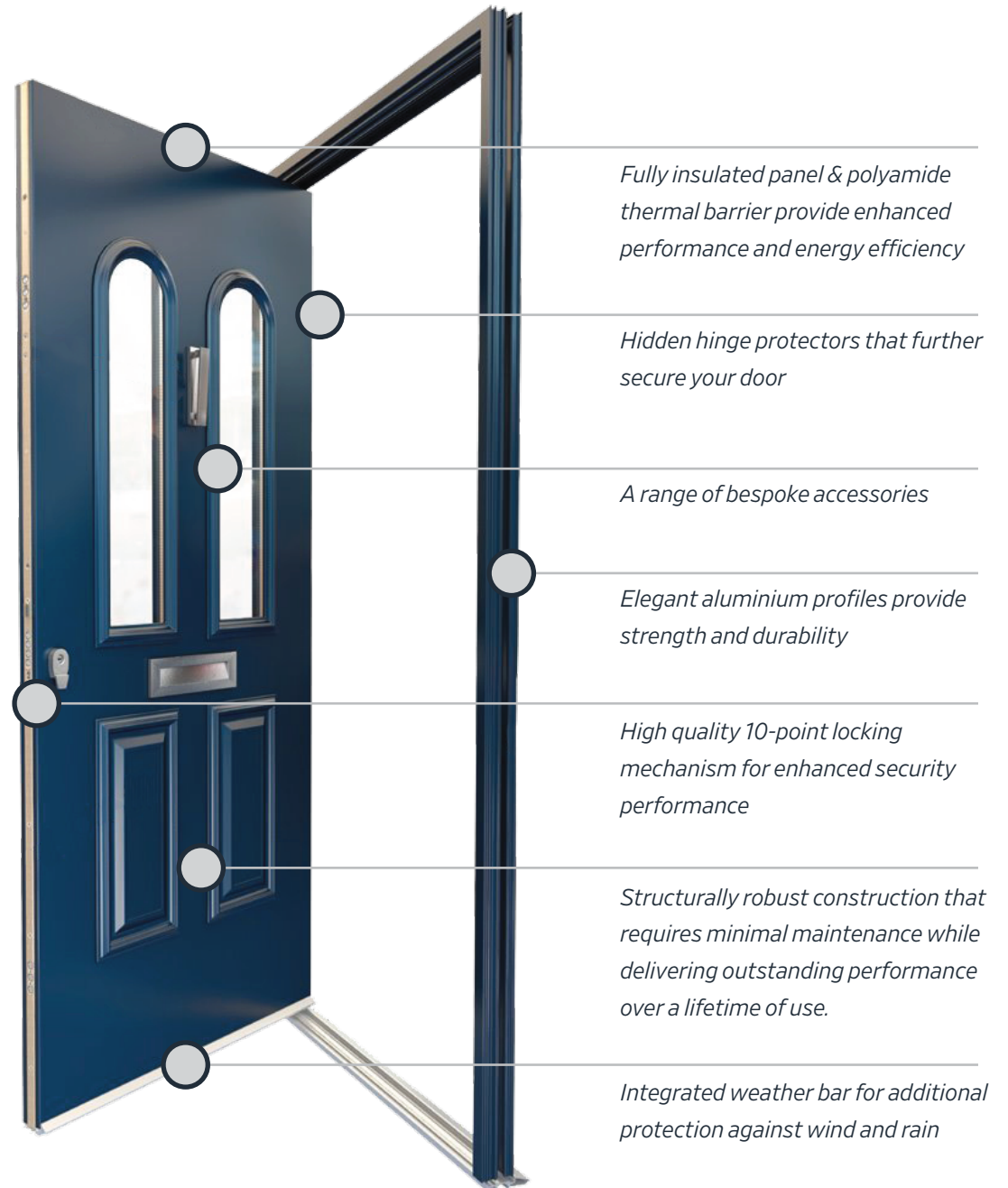

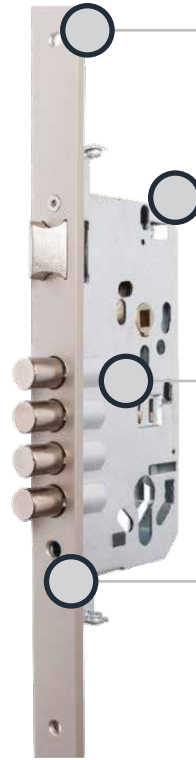

Door sashes sit flush internally and externally with the outer frame for an elegant finish

'Block door' construction incorporates a **totally hidden sash** and fixing system for added security

Lock body is encased and protected by the hidden door sash and external aluminium skin, **creating an additional 5mm of external aluminium wall.**

High security **10-point lock** and escutcheon plate system, with a drill proof 'anti-bump' cylinder, fitted as standard



DOORS

We offer a range of high-security, robust doors to complement our window range, Anything from a functional rear door, French doors to open up a patio or balcony area, to a range of bespoke entrance doors complete with a choice of designer stainless steel handles and feature panels. The choices and colours are practically endless.

Our ranges of doors suitable for the architectural, commercial, public, new build and retail markets. The doors available are commercial hinged, commercial swing, patio, tilt and slide, slide folding, multi-track slide and automatic. Doors are designed for use as open out or open in, single or double doors, internally or externally beaded with sidelight options for domestic and/or commercial applications.

47mm or 70mm System Available:

- New adjustable hinges and lock keeps
- Single & double doors use multi-point locking mechanisms
- Double doors feature dual lock mechanisms enabling handles on both sashes
- Door sections & hinges are designed with added strength delivering robust performance
- Internally beaded for open in and open out doors
- Profiles are contemporarily styled with a modern, square-edge design
- Low thresholds comply with Document M building legislation
- Z/T sash sections allow for greater coverage and weather resistance



CREATE AN ARCHITECTURAL LOOK AND FEEL



PANEL DOOR WITH POLE HANDLES



ALITHERM PLUS FRENCH DOORS

CONSERVATORY STRUCTURES

The classic conservatory is a great way of creating extra living space without extending your home. They traditionally offer a great vantage point to enjoy a garden as they contain more glass than wall space.

Orangeries are also great for creating more living space. They are both traditional and contemporary - with brick pillars, they tend to have more wall than glass which makes them a more private room than a conservatory.

We can create a conservatory extension to fit most spaces. Create lots of natural light and airy spaces with an Allstyle conservatory. Available in a huge range of colours and designs, there is a suitable solution for all projects.

Our conservatory roof systems are an excellent standard and very well thought-out. By offering many options for tackling difficult sites, where box gutters and other features are required, we also consistently come up with innovative solutions to design problems.



EXTEND YOUR LIVING SPACE



ENJOY YOUR GARDEN ALL YEAR ROUND

LANTERNS & ROOFLIGHTS

Whether you are replacing an existing roof, or building a new extension, an Allstyle lantern roof is an ideal way to draw more natural light into your room.

Our lanterns offer exceptional benefits - both the internal and external appearance complement any home, flooding it with as much natural light as possible.



MINIMAL EXTERNAL STRUCTURES

FULL ALUMINIUM ROOFS

Ultra slim frames are achieved with the impressive strength to weight ratio of aluminium and ensure that sightlines are minimal. As our rooflights are fully aluminium, with no plastic caps, bosses or hoods, we can design roofs in any RAL colour to complement existing or additional home improvements made in aluminium.

The thermal insulation in an aluminium roof will ensure that your room is comfortable all year round. You will also reduce the risk of condensation and cloudiness.



OPTIMAL VIEWS



REDUCED SIGHTLINES

ULTIMATE PERFORMANCE



FLOOD YOUR ROOM WITH NATURAL LIGHT

OVERALL
U VALUE
(FRAME AND
GLASS) 1.3 W/M²K
GLASS U VALUE
1.0 W/M²K

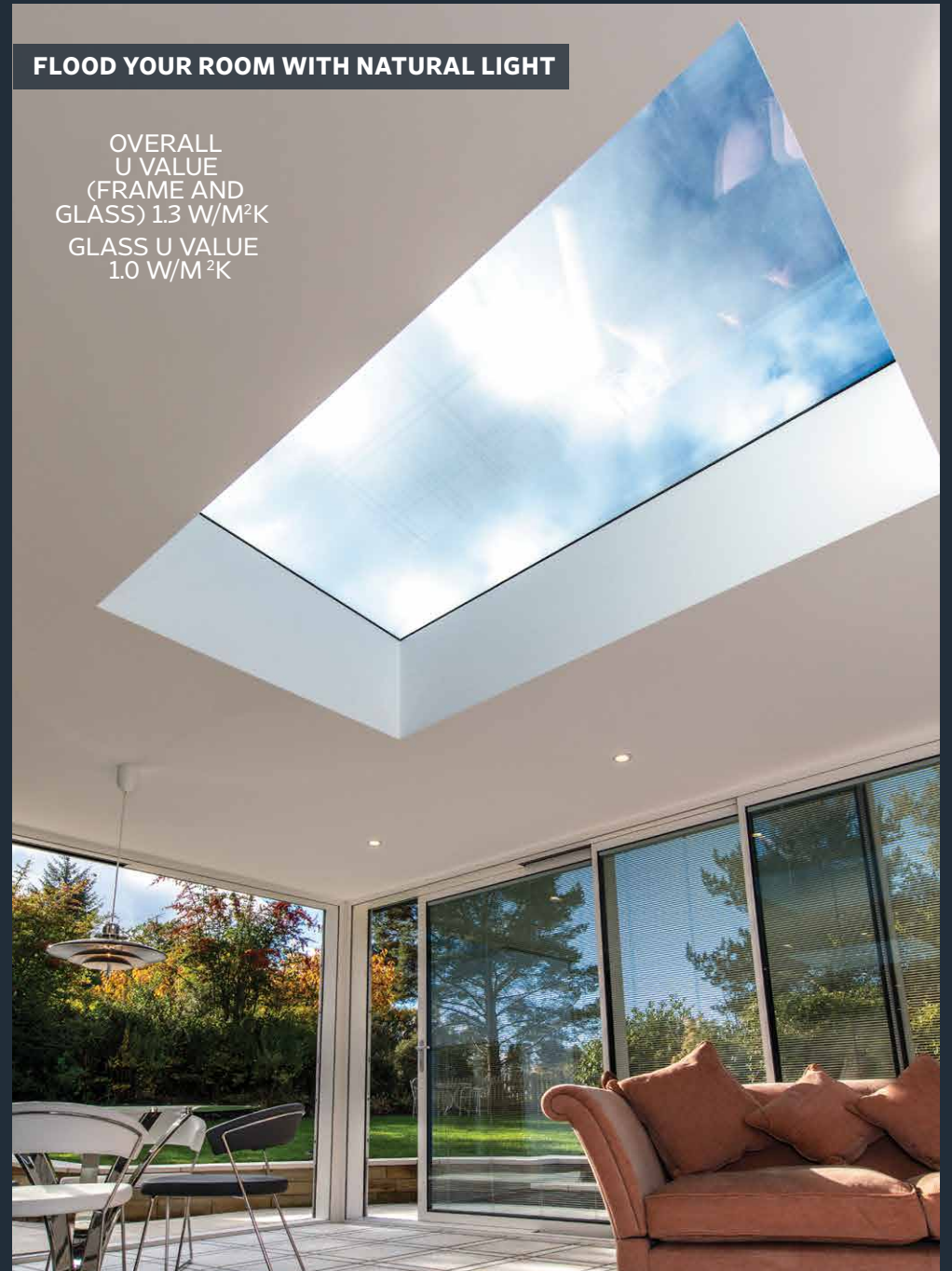

MAXIMUM LIGHT

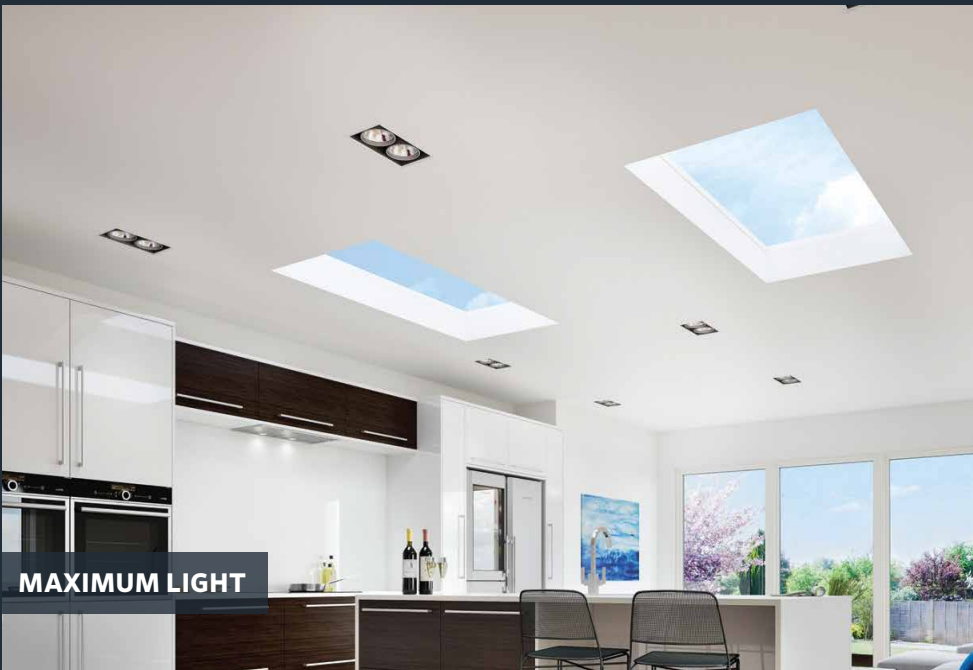

YOUR LOCAL SPECIALIST SUPPLIER IS:

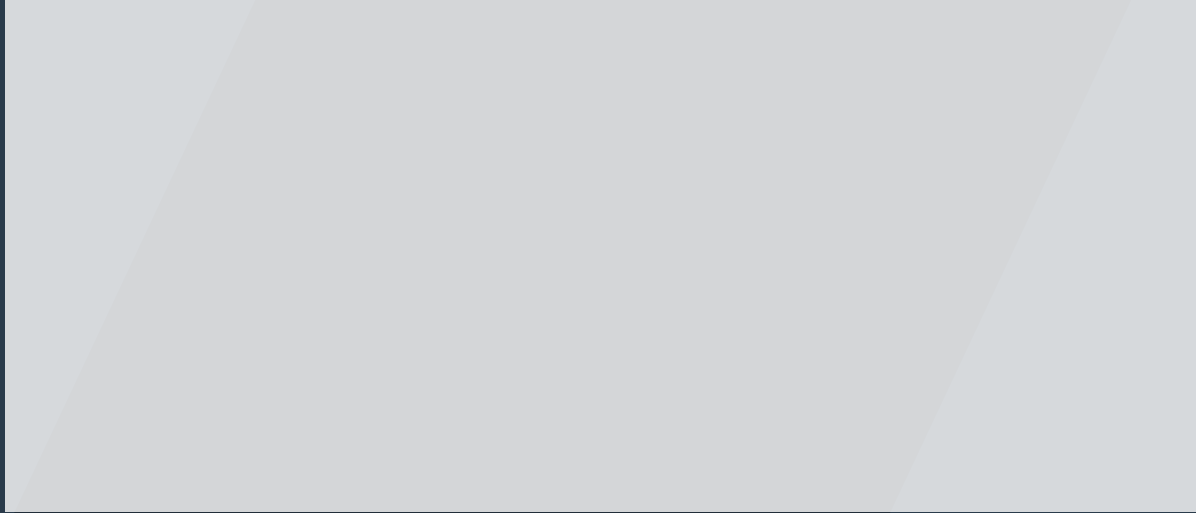

Disclaimer: From time to time, dimensions, hardware and designs of our products will change to reflect product development. Accordingly, photographs, drawings, and product dimensions may not always be accurately represented on our website or in brochure material. In addition material colours on our website and brochures are representations only. Printing and computers only show an approximation. Customers should choose colours from actual samples. Before purchasing any product you should check with your installer as to the current design, dimension and exact colour of any product.